



***INTELLISPEC™ CP830
with Driver Module
Addendum Series 6***

MANUAL PART NUMBER: 82480 REV. 01

HARDWARE MODEL NUMBER(S): 81875

Copyright Notice / Contact Us

© 2021 Pressco Technology Inc. All rights reserved.

No part of this manual may be reproduced or transmitted in any form or by any means, electronic or mechanical, including photocopying and recording, for any purpose, without the express written permission of Pressco Technology Inc.

The contents of this manual are furnished for informational use only, are subject to change without notice, and should not be construed as a commitment by Pressco Technology Inc.

Written and designed at:

Pressco Technology Inc. World Headquarters

29200 Aurora Road

Cleveland, OH USA 44139-1847

TEL +1-440-498-2600

FAX +1-440-498-2615

www.pressco.com

Business Hours: Monday - Friday, 8:00am - 5:00pm Eastern Time

Customer Support:

Request technical support and remote support: techsupport@pressco.com

24/ 7 Customer Support (for urgent system help): +1-440-498-2000

e-mail: Schedule a service visit: dispatch@pressco.com

Request technical support and remote support: techsupport@pressco.com

Customer Service Fax: +1-440-498-4761

Table of Contents

Chapter 1 Pressco Introduction	5
About This Manual	5
Safety Considerations	6
Static Discharge Protection	6
Chapter 2 Safety Information	7
Health Warning - Photosensitive Epilepsy	7
Symbols Used With This System	8
Arc Welding Warning	9
Label Description - Intellispec	9
Warning Devices	10
Light Tree	10
Residual Risk	10
Intended Use	10
Prohibited Use	10
Personal Protective Equipment	11
Personnel Safety	11
Lifting Heavy Objects	12
Authorized Users	13
Spare Parts Usage	13
Chapter 3 System Specifications	15
Environmental Conditions	15
Electrical Specifications CP830 Series 6	15
Sound Pressure Level	15
Chapter 4 Installation	17
Shipping and Handling	17
Recommendations Prior to Installation	17
Assembly, Location, and Mounting Requirements	18

Installation	19
Commissioning	20
Chapter 5 CP830 Inspection Module S6	21
Inspection Module Adjustments	21
Observe the Part Image	21
Adjust the Camera Position	22
Lighting Adjustments	23
Wiring Diagram CP830 S6	24
Chapter 6 Controller-Driver Box with Trigger Output	25
Wiring Diagram Controller-Driver Box	26
Chapter 7 Maintenance Frequency with Chromapulse Modules	27
Maintenance for the Inspection Module	27
Cleaning Optical Surfaces	27
Cleaning Glass Surfaces	28
Cleaning the Chromapulse Beam Splitter	28
Cleaning Plastic Surfaces - general	29
Cleaning the Part Detector Without Reflector	29

Chapter 1 Pressco Introduction

Welcome!

Congratulations on your purchase of an Intellispec system! The Intellispec is a high-speed machine vision system designed specifically for product and online process monitoring. It is a powerful tool that provides inspection much more reliably than the human eye or sampling methods. The latest PC technology, powerful inspection algorithms, online adjustment capability, and inspection data storage allow the Intellispec to automatically inspect parts with extreme accuracy on high-speed lines.

The Intellispec will help you provide the highest quality of products shipped to your customers.

About This Manual



IMPORTANT: Keep this manual for future reference

This book is considered an integral part of the system and should be kept handy for future reference as long as the system is being used in your plant.

The purpose of this manual is to describe one or more inspection modules. It is intended for Administrators and trained users.

This manual:

- Is your responsibility to keep in good condition, in a dry place, and ready for consultation by the authorized users of the system.
- Contains the technology implemented at the time of selling and supplying the system and shall not be considered inadequate in case of technological enhancements in the machine or in the manual's illustrations.

Related books include:

- Intellispec Operator's Guide which has Operator-level user instructions, and is a good place to start if you are new to Intellispec
- Intellispec Software Guide which has Administrator-level user instructions
- Intellispec Hardware Guide (multiple options), which describes the vision processor and cabinet

The following types of alerts may appear in this guide:



DANGER! - Danger messages alert you to specific conditions that can cause serious or fatal personal injury. Danger messages give you important information which must be observed to prevent injury.



WARNING: - Warning messages indicate information which must be observed to prevent injury, data loss, or equipment damage.



CAUTION - Caution messages indicate important information which must be observed to prevent: loss of data, poor system performance, or equipment damage.

Note: Notes contain special information that warrants being set off from the body text as shown here.



IMPORTANT - Indicates prerequisites or information that must be observed to complete or understand a concept or task.

TIP: Provides helpful hints for completing a task.

Safety Considerations

Observe the following safety warnings when operating the system or working near it:



WARNING - Potential for projectiles to strike persons and cause injury. Keep clear of reject devices.



WARNING - Sensitive electronics and High Voltages may be exposed. Keep Processor Cabinet/ Electrical Control Box door closed.

Static Discharge Protection



Caution - Electronic components can be damaged by static electricity discharge.

Always observe the following precautions before removing, installing or handling any electronic components within the Inspection System:

- Wear an anti-static wristband which is grounded to the Inspection System.
- Stand on an anti-static, grounded floor mat, and lay circuit boards on the mat during any board replacement.
- Keep circuit boards in static shield bags when storing and transporting. Ensure the bag is sealed.

Chapter 2 Safety Information

This section contains operator safety information that must be read before operating or servicing the system.



WARNING - This product contains no operator serviceable parts. Refer servicing to qualified personnel. To prevent electrical shock do not open cabinet doors whilst power is connected.



WARNING - Do not, under any circumstances, tamper with sealed machine parts or devices. This could result in the removal of protections that might create potentially hazardous conditions.



CAUTION - Possible hazardous optical radiation from LEDs. Do not stare at lamps.

Health Warning - Photosensitive Epilepsy



WARNING: PHOTOSENSITIVE EPILEPSY/ SEIZURES

A small percentage of individuals may experience epileptic symptoms or seizures when exposed to certain patterns or flashing lights. Exposure to the flashing lights in vision inspection systems may also trigger epileptic symptoms or seizures in these individuals. These flashing lights may trigger epileptic symptoms or seizures in persons who have no history of epileptic symptoms or seizures. If you, or anyone in your family has an epileptic condition or has had seizures of any kind, consult your physician before operating this machinery.

IMMEDIATELY DISCONTINUE use and consult your physician if you experience any of the following symptoms while operating this machinery:

- Dizziness
- Altered vision
- Eye or muscle twitches
- Loss of awareness
- Disorientation
- Seizures
- Any involuntary movement or convulsion

Epileptic symptom or seizure triggers vary from person to person. Some common triggers are:











- Flashing lights used for vision inspection systems or fire alarms
- Certain video games or TV broadcasts containing rapid flashes or alternating patterns of different colors
- Bright, contrasting patterns such as white bars against a black background
- Flashing white light followed by darkness
- Stimulating images that take up your complete field of vision, such as being very close to a TV screen or computer monitor
- Certain colors, such as red and blue

If you encounter something that might trigger epileptic symptoms or seizures without warning:

- Do not close your eyes (this could cause a flicker effect)
- Do not look directly at the flashing lights or trigger source
- Do cover one eye with the palm of your hand immediately
- Do turn away from the flashing lights or trigger source

Symbols Used With This System

The following symbols are used on or near the Pressco system. Be aware of potential risk hazards.

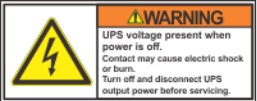
Symbol	Meaning
	CAUTION: Risk of danger. Refer to accompanying user documentation before use.
	WARNING: Risk of electric shock
	WARNING: Arc flash and shock hazard
	WARNING: Risk of electrical shock
	WARNING: Risk of burns from hot surface
	WARNING: Hand crush hazard
	On (supply)
	Off (supply)
	Alternating current
	Protective conductor terminal
	Warning: Arc flash and shock hazard
	Warning: UPS voltage present when power is off

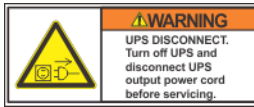

Warning: UPS Disconnect

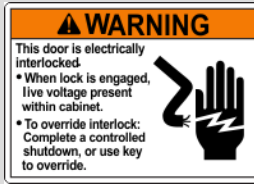

Warning: Electrical interlock



Danger: shock and arc flash explosion hazards

Arc Welding Warning

⚠ WARNING - Potential equipment damage can occur if the vision equipment is not fully powered down prior to any arc welding performed on the line where the vision equipment is installed, specifically but not limited to our encoders.

Label Description - Intellispec

The following illustration shows an example label that you will find on the Intellispec system components.

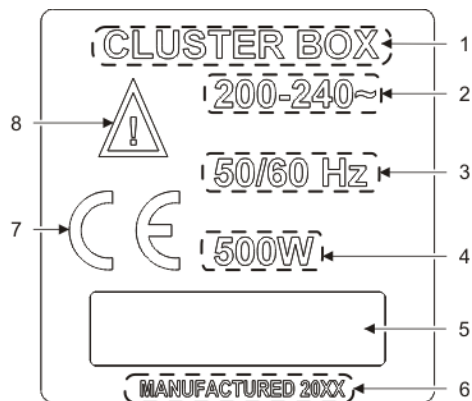

- 1) Name of component. NOTE: The Chromapulse model is listed on the front panel of the module.
- 2) Voltage range in Volts AC
- 3) Frequency range in Hertz (Hz)
- 4) Maximum rated power in watts (W) with all accessories or plug-in modules connected
- 5) Serial number is listed in this box
- 6) Year of manufacture
- 7) Component certification
- 8) Risk of danger. Refer to accompanying documentation before use.

Warning Devices

The Pressco system has warning devices that indicate system failure or report excessive defects or warnings for your production line. These include an optional light tree, alarms and indicators on screen, and audible warnings (depending on system).

Light Tree

The optional light tree is mounted on a pole in a customer-specified location.



The light tree color segments represent each alarm or system condition. A color segment may appear for more than one alarm condition.

Residual Risk

The Pressco system has been designed to minimize any danger of personal injury. However, the system uses rejection devices to remove defective product from the production stream. Also, the electronics cabinets contain risk of shock if they are opened.

Observe the following safety warnings when operating the system or working near it:



WARNING - Potential for projectiles to strike persons and cause injury. Keep clear of reject devices.



WARNING - Sensitive electronics and High Voltages may be exposed. Keep Processor Cabinet/ Electrical Control Box door closed.

Intended Use

Type of Process The Pressco system is intended to monitor container and other special manufacturing processes and identify non-conforming product.

Intended Use The Pressco system is designed and constructed for use in an indoor industrial environment, always sheltered from the weather.

Space Required The Pressco system and accompanying sensors must be installed in a place that will enable safe and easy installation, size changeover, user operation, and maintenance procedures.

Prohibited Use



WARNING - If this instrument is not used as specified, the protection provided by the equipment could be impaired. This instrument must only be used in a normal condition (in which all means of protection are intact).



Important - The Pressco system should NOT be used for any purpose other than specifically indicated in the section titled "**Intended Use**" above.

The following uses are not intended:



Use in an explosive environment



Use in a flammable environment



Use in a damp, moist, or wet environment, except where specifically indicated

Personal Protective Equipment



Important - Always follow the safety requirements of your plant in addition to the recommendations below.

We recommend, at minimum, use of the following Personal Protective Equipment (PPE):



Protective clothing



Protective gloves



Protective ear plugs or headphones



Protective eye wear



Protective foot wear

Personnel Safety

The following rules are recommended to ensure the safety of personnel in charge of machine operation and maintenance.

During machine operation:



Only one operator is needed to operate the machine. All others must keep at a safe distance.



Operators must be familiar with all machinery connected to the Pressco equipment and know how to use emergency stop devices.

Note: the emergency stop devices may not be connected directly to the Pressco equipment, but it is important to know how to use them.



Before putting the Pressco system online, the operator must ensure that all safety devices used with all connected machinery are in place and operational.

Do not operate with guards removed.



The operator must maintain maximum focus on his work and be alert throughout his shift. If this is not the case, immediately inform the shift supervisor.

When carrying out maintenance or repair work:



Disconnect master switch. For switch locations, refer to the Power Up and Power Down section.



Before starting the machine, ensure that no person is close to the machine.



If maintenance or repair requires the disconnection or removal of safety or protection systems, this operation must be supervised by authorized personnel who must ensure the prevention of personal injury or damage to the machine. All machine movements must be performed with limited speed and limited movements.



Maintenance or repair work on electrical components must be carried out exclusively by authorized, trained personnel. When running tests with power connected, you must strictly comply with the rules provided.



Personnel working on higher parts of a machine must wear a harness and hook it on to the structure and must always move with extreme caution.



Never perform lubrication or maintenance procedures on mechanical parts with the machine running.

For your safety, do not:



Open safety guards during machine operation



Perform maintenance and repair while the system is running



Lean on the machine



Sit on the machine components



Use the machine for purposes other than those listed in this manual



Modify parts of the machine



Allow unqualified personnel to operate or perform maintenance procedures on the machine

Lifting Heavy Objects



CAUTION - Some components are heavy. Take proper precautions to prevent personal injury or damage to equipment. If you are not capable of lifting the object alone, ask a capable person to help lift the object, or use a mechanical lifting device

The components do not have handles to lift the equipment. Be sure to:

- Lift equipment from the bottom - do not use wires, brackets, nor other protrusions
- Keep fingers away from sensor lenses to keep the equipment clean
- Proceed slowly



WARNING- *The Pressco cabinets must NOT be lifted by one person. Use a mechanical lifting device, and ask another person to assist you.*



Do not twist your body when moving the load. Instead take small steps with your feet turning until you are in the correct position.

To safely lift equipment:

1. Stand close to the load and center yourself over it with your feet shoulder width apart.
2. Tighten your abdominal muscles.
3. Keeping your back straight, bend your knees and squat down to the floor.
4. Get a good grasp on the load with both hands.
5. Keeping the load close to your body, use your leg muscles to stand up lifting the load off the floor. Your back should remain straight throughout lifting, using only the muscles in the legs to lift the load.
6. To place the load in the appropriate spot, bend at the knees using only your leg muscles to lower the load.

Authorized Users

Trained machine operators, mechanic and electrical maintenance staff, and plant managers are considered authorized users of the Pressco system. These users should carefully read the information contained in this manual. The plant manager must ensure that the safety recommendations included in this manual are observed.



WARNING - *Allowing workers who are unfamiliar with the production process to operate the Pressco system could result in hazard risk.*

If you are unclear about any part of this manual, contact Pressco Technical Support.



Important - *No worker should ever operate the system outside of his/ her own area of competence and responsibility.*

Proper Operation: Only one worker is to operate the system at any given time. The correct position for the operator is in front of the user interface monitor or control enclosure (if applicable).

Repairs: Any repair on the system shall be carried out exclusively by Pressco Technology Inc. service personnel or by other service expressly authorized by Pressco Technology Inc.

Spare Parts Usage

The following restrictions apply to replacing parts:



WARNING - *Using spare parts that are not designed to Pressco's specifications can compromise the safety and effectiveness of the Pressco system.*

- The use of parts that are not within Pressco's design specifications is prohibited. This prohibition applies in particular when the parts involved contain or are connected with safety devices.
- Before resuming production, make sure all safety devices are in working order.

Chapter 2

Pressco Technology Inc. shall not be liable in any way if any of the above-described directions are not complied with.

To obtain a spare parts list, contact the customer service department at Pressco.

Pressco's technicians are available to help customers, in their own plant, to solve any problem that might arise during use and maintenance of the system.

Chapter 3 System Specifications

This instrument has been designed and tested in accordance with Publication EN61010-1 (2010) Safety Requirements for Electrical Equipment for Measurement, Control and Laboratory Use and has been supplied in a safe condition. The instruction documentation contains information and warnings which must be followed by the user to ensure safe operation and to maintain the instrument in a safe condition.

Environmental Conditions

The Intellispec system is designed to be safe in the following environmental conditions:

Note: Please consult Pressco Technology Inc. if your environmental conditions are outside of those listed.

Condition	Specifications
Indoor/ outdoor use	Indoor use only
Altitude	Up to 2000 meters
Operating Temperature	5 °C to 50 °C
Storage Temperature	0 °C to 70 °C
Humidity	Maximum relative humidity 80 % for temperatures up to 31 °C decreasing linearly to 50 % relative humidity at 50 °C
Mains supply	Voltage fluctuations up to ± 10 % of the nominal voltage
Overvoltage protection rating	Transient overvoltage typically present on MAINS supply NOTE: the normal level of transient overvoltages is impulse withstand (over-voltage) category II of IEC 60364-4-443.
Rated pollution degree	This instrument is designed for use in Installation Category II and Pollution Degree 1 as per EN61010-1 and EN60664 respectively.



Warning - This is a Class A product. In a domestic environment this product may cause radio interference in which case the user may be required to take adequate measures.

Electrical Specifications CP830 Series 6

The Cluster Box provides power to the Controller Box and CP830 (non-E):

12VDC, 1A max.

48VDC, 1A max.

Sound Pressure Level

The horn on the optional light tree has a maximum 105dB level at 1 meter distance in front of the horn. Use proper hearing protection as specified by your plant safety instructions.

Chapter 3

This page left blank intentionally

Chapter 4 Installation

This section contains information about installation requirements and preparations that need to be complete before installing the system.

Shipping and Handling

Pressco Technology Inc. ships unassembled components in packing cases designed to protect the contents during handling and from exposure to weather.

Unless otherwise specified in the contract with the machine order, the Customer shall supply Pressco Technology Inc. with the means and equipment necessary for the unloading, lifting, and handling of machine parts. Pressco Technology Inc. deems it important to have one of their technicians supervise the process of unloading, handling, and lifting the machine. The technician can give useful advice as to the logical sequence in which the components should be unpacked and positioned for ease of assembly.

 **WARNING** - Only qualified personnel must be involved in the operation of unloading, handling, and lifting the machine. Pressco Technology Inc. shall not be liable for damage to components and/or personal injury resulting from the involvement of unauthorized personnel and/or failure to comply with the directions provided in this manual in relation to lifting and transport.

 **Important** - The site supervisor will be responsible for ensuring that all the various mounting phases are carried out safely and in compliance with current regulations.

After the machine is delivered, check for any damage that might have occurred during shipping. In case of damage, contact Pressco Technology Inc.

In handling the machine, always keep it close to the ground.



We recommend using a forklift truck with adequate capacity and forks to suit the weight to be lifted (machine plus packaging).

The dimensions and weight of a crate are listed below. Note that this is the maximum size and weight. The size and weight of the crate may be less depending on your configuration. You may receive multiple crates depending on your configuration.

Size (full Intellispec system)	152.4 cm x 124.46 cm x 152.4 cm (60 x 49 x 60 inches)
Weight (full Intellispec system)	453.592 kg (1000 lbs.)

Recommendations Prior to Installation

Before the machine is installed, the Pressco installer, together with the Customer (or representative) shall check the following criteria in the environment where the machine is to be installed:

- Work required by contract for the installation of the machine has been carried out
- The plant layout drawing that describes where the machine will be installed is the final drawing agreed to by Pressco Technology Inc.

- The space and height required for installation are actually available
- Only the components included in the installation layout are present in the area where the machine is to be mounted. Ensure no machines or components have been added at a later stage that might hinder mounting or make it more difficult. Should this be the case, immediately contact Pressco's Project Engineering personnel to arrange a suitable solution to the problem.

We recommend the following prior to machine installation:

- Transport the machine in its packaging to the area where it will be installed to minimize possibility of damage
- Carefully remove the packaging material and check components for damage
- Check tightness of mechanical components, as they can loosen during transport
- Prepare the compressed air mains line. Before making final connections, ensure that the pipes are clean and free from any debris.

Assembly, Location, and Mounting Requirements

Utilities to be Supplied by Customer

The following utilities are required to operate the Pressco Intellispec system. Before making connection, make sure the utility matches the technical specifications. More than one connection of the utilities may be required depending on the number of modules installed. Refer to specific wiring diagrams.

Utility	Requirements
Air supply for rejection device	Pipe size must be such that there will be no pressure decrease during machine operation. Air must be dry and free of oil.
Electrical supply	<p>Provide one each electrical socket to comply with:</p> <ul style="list-style-type: none"> • User interface electrical specifications (use the specifications that apply to your system) • Integrated tunnel electrical specifications (if applicable) • Cluster box electrical specifications (if applicable)
Internet connection (optional)	Provide a shielded ethernet cable to use Pressco's remote support through the Internet.

Protective Earthing

This product must be grounded (earthed). If it should malfunction or break down, grounding provides a path of least resistance for electric current to reduce the risk of electric shock.

 **DANGER** - Improper connection of the equipment grounding conductor can result in a risk of electric shock. Check with a qualified electrician or service technician if you are in doubt as to whether the product is properly grounded.

Cord Connected Equipment

Chapter 4

The product will be equipped with a supply cord having an equipment grounding conductor and a grounding plug. The plug must be plugged into an appropriate outlet that is properly installed and grounded in accordance with local codes and ordinances.

Do not modify the plug provided with the product - if it will not fit the outlet, have a proper outlet installed by a qualified electrician.

Cable Direct

This product must be connected to a grounded metal, permanent wiring system, or an equipment grounding conductor must be run with the circuit conductors and be connected to the equipment grounding terminal.

Electrical Connection

Make sure that the power outlet voltage matches the voltage required by the machine. Refer to the electrical specifications and wiring diagrams for your system.

⚠ WARNING - Power Switch is the power disconnect device. Do not position the equipment such that access to the disconnect switch is impaired. If not readily accessible (such as within a rack or mounting out of reach), an additional disconnect device should be installed that can isolate the Live and Neutral lines of the mains power supply, whilst leaving the protective earth intact.

Reject Valve Pneumatic Diagram

This diagram shows the reject device connection to the 8-port I/O box. This is for Intellispec systems.

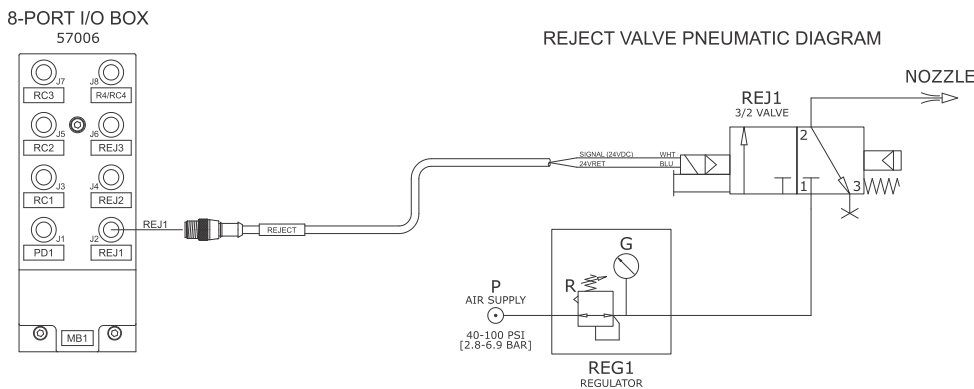

Installation

Pressco Technology Inc. recommends that the machine be installed and assembled by Pressco's specialized technicians. This is of vital importance for correct machine operation.

⚠ WARNING - Pressco Technology Inc. shall not be liable in case of failures or damage to property and/or personal injury resulting from or connected with assembly if this has been carried out by unauthorized personnel, or is not in compliance with the indications given in this manual.

To carry out production and cleaning/ servicing operations, it is important for the machine to have a minimum amount of space all around and away from walls.

Ventilation

Place the Pressco Intellispec components in a position with adequate ventilation to allow proper air flow through the air filters.

Component	Spacing
User Interface	Leave 1 meter [39 inches] clear around machine
Cluster box (not used on all systems)	Leave 100 mm clear in front of the fan and vent

Commissioning

Before placing the machine into operation, make sure the following checks are completed:

Completed	Yes	No
Positioning and leveling of the unit		
Connection of compressed air line to connection points		
Connection of power supply to vision processor cabinet		
Connection of power supply to cluster box (if applicable)		
Connection of power supply to integrated inspection module(s) if applicable		
Proper wiring from user interface cabinet to sensor module(s) and cluster box (if applicable) using the wiring diagrams		

Chapter 5 CP830 Inspection Module S6

This section applies to model number 81875, F2076.

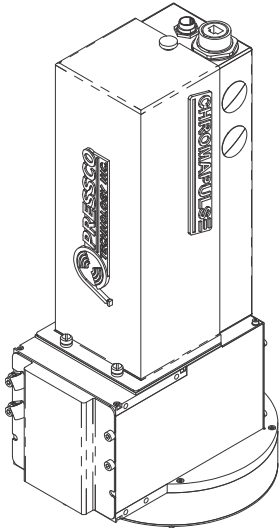

Inspection Module Adjustments

Inspection module adjustments include the camera position, aperture, and camera focus.

The focus adjustment controls the clarity of the image; the aperture adjustment controls the amount of light admitted by the shutter. Normally the inspection modules do not require further adjustment after initial system setup. Circumstances that might require additional adjustments are camera replacement, strobe replacement, or a substantial change in part size or color.



Danger - The inspection modules are mounted near moving machinery. Use extreme caution to avoid contact with moving machinery when servicing inspection modules as serious personal injury could result. Ensure machinery is in an emergency stop state before servicing inspection modules.

Observe the Part Image

When adjusting the focus, aperture, or height for any inspection module, it is helpful to use Offline Imaging so that you can immediately see the effect of an adjustment on the image quality.

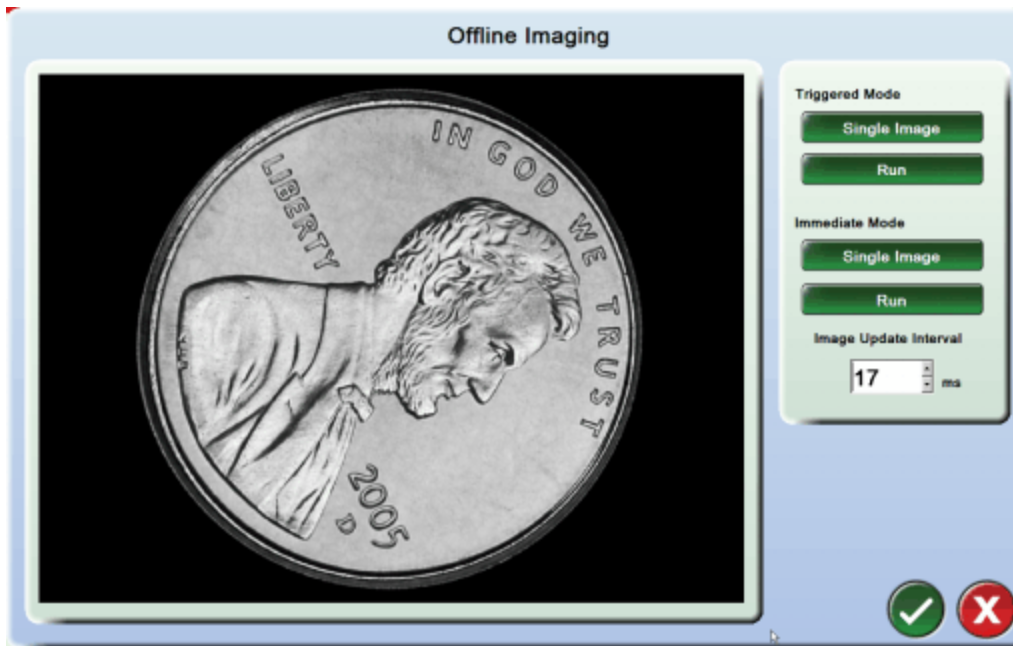

To use Run in Immediate Mode:

1. Make sure the lane is offline.



2. Right-click a sensor button.
3. Select Offline Imaging from the menu.
4. Click the Run button under Immediate Mode, then run a part through the inspection module.

While the system is in this mode, you will be able to make adjustments to focus, aperture, or camera height.

Adjust the Camera Position

⚠ WARNING - Keep clear of reject devices. Projectiles may cause injury.

If you switch to a new type of part that is significantly larger or smaller than the previous part type, you may need to adjust the camera height.

Make sure that the part image is fully in the camera view, but with enough room outside the part for the image to move from part to part.



1. Carefully open the door of the module.
2. Make a note of where the camera currently is. You could use a marker to mark the ruler, or write a note in the part program using the "Edit Notes" feature from Manage Part Programs.
3. Observe the Part Image on the monitor.

4. While holding the camera, unlock the lever to release the camera position [1].

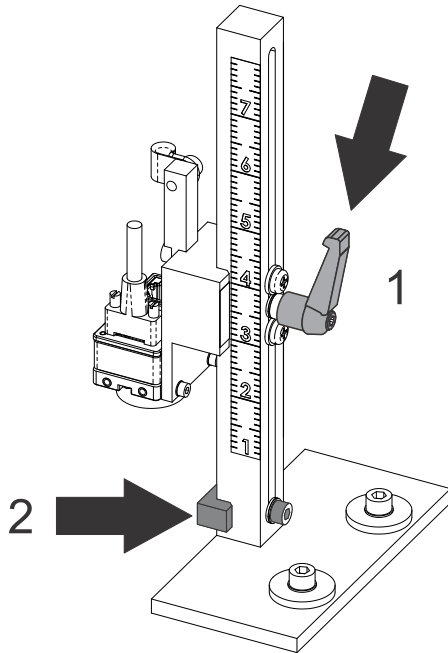

5. Move the camera to the new desired position.
6. If the camera is at its lowest position for your part sizes, adjust the stop to that position [2]. You can use that position in the future to easily locate the lower position.
7. Make sure the focus and aperture are still good.
8. Lock the camera lever.
9. Close the module cover.

Lighting Adjustments

To adjust the lighting, use the software adjustments.

To see the image on the screen:

Observe the Part Image

Adjust lighting through either:

- Basic adjust lighting, or
- Advanced adjust lighting

Most often, you will use Basic Adjust Lighting.

Wiring Diagram CP830 S6

DOC. VERSION	DOCUMENT NO.
01	F2076W
	PAGE 1 of 1

SEE P/N:
81559
81560

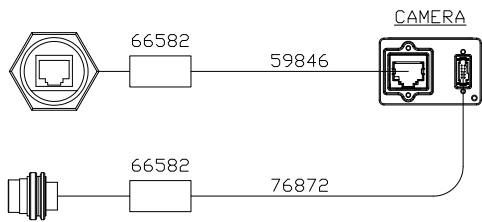

ARRAY INTERFACE PCB
76790

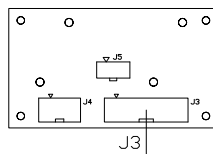

UPPER ARRAY CABLE

FERRITE DETAIL
INSTALL FERRITES ON
CABLES AT SIDE PANEL

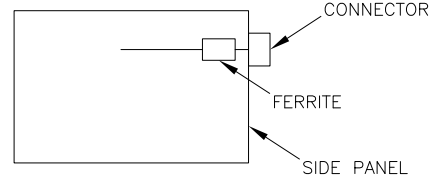

Chapter 6 Controller-Driver Box with Trigger Output

Reference box part number 76911, F1840

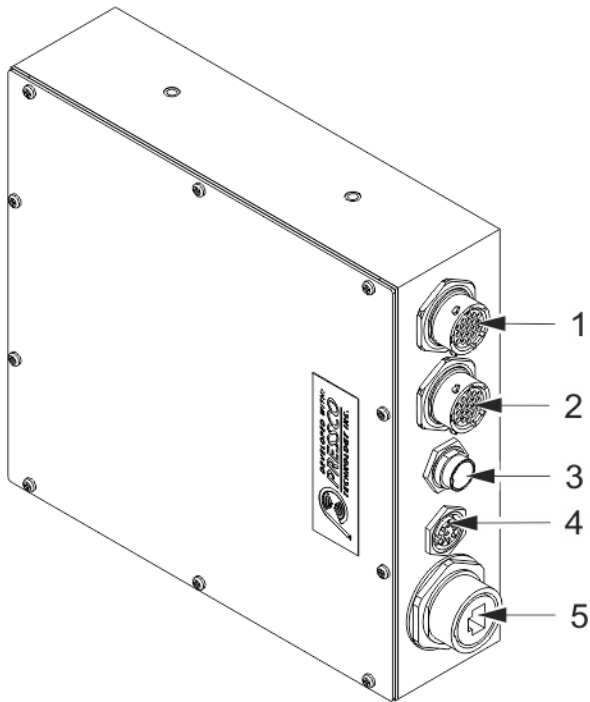

- 1) Array Two (if required)
- 2) Array One
- 3) Power/ Trigger Input
- 4) Power/ Trigger Output
- 5) Ethernet

Wiring Diagram Controller-Driver Box

DOC. VERSION	DOCUMENT NO.
02	F1840W
	PAGE 1 OF 1

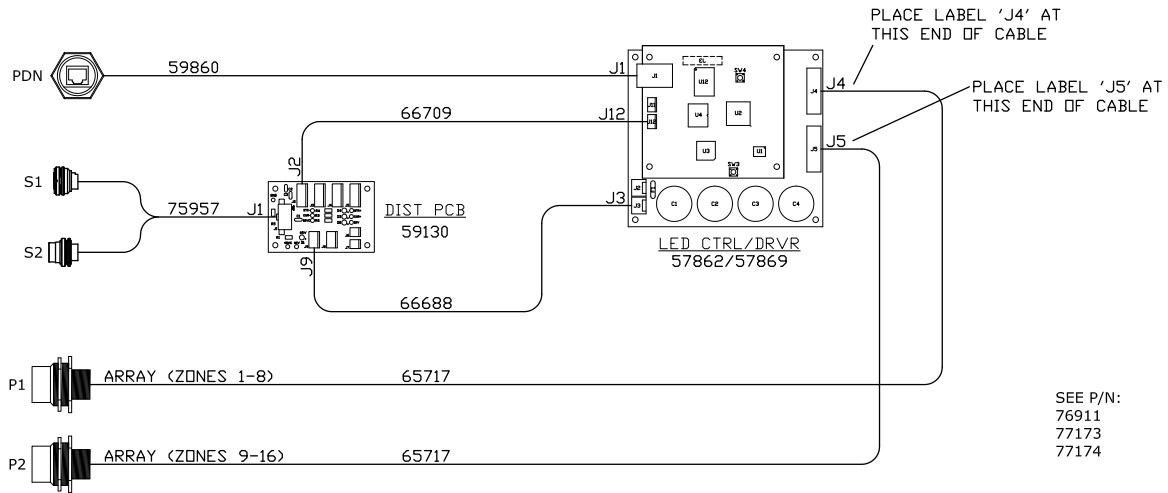

SEE P/N:
76911
77173
77174

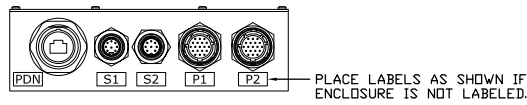

Chapter 7 Maintenance Frequency with Chromapulse Modules

Item	Description	Frequency
Observe proper rejection	Verify that defective parts are being rejected by inserting a known defective part through inspection	Daily
Observe Proper inspection	Verify that no stray parts are stuck in or near the inspection module or reject station	Daily
Observe Proper inspection	Verify that no buildup of dirt or contaminants has occurred on inspection module. Clean if necessary.	Daily
Observe Proper inspection	Verify that each camera's image is properly centered, focused, and properly lit. Adjust if necessary.	Daily
Glass surfaces	Clean with soft, clean, oil-free cloth dampened with glass cleaning solution	Daily
Plastic surfaces	Clean with soft, clean, oil-free cloth dampened with mild soap and water solution	Daily
Part Detect Sensor and Reflector	Clean with soft, clean, oil-free cloth dampened with mild soap and water solution. Wipe dry.	Weekly
Support Package	Create a snapshot of your Intellispec settings.	Monthly
Camera lens	Clean only with lens tissue and lens cleaner. Be careful not to alter focus or aperture.	Monthly
Fan filters	Rinse in clean water; use mild soap and water solution if oily.	Monthly
Acronis Backup	Create a full System Backup.	Yearly

Maintenance for the Inspection Module



Important - Debris and contamination could build up on both the glass and plastic surfaces. This dirt could appear in the inspection windows, causing false rejects of parts, or it could degrade lighting. Clean glass and plastic surfaces often to avoid false rejects.

To maintain proper image quality and system performance, the clear glass and plastic surfaces on the Inspection Modules must be cleaned on a regular basis. Dirt and debris that appear in the image can cause false rejects. An oily film on optical surfaces can cause false rejects or missed defects.

Cleaning Optical Surfaces



Important - Debris and contamination could build up on both the glass and plastic surfaces. This dirt could appear in the inspection windows, causing false rejects of parts, or it could degrade lighting. Clean glass and plastic surfaces often to avoid false rejects.

To maintain proper image quality and system performance, the clear glass and plastic surfaces on the Inspection Modules must be cleaned on a regular basis. Dirt and debris that appear in the image can cause false rejects. An oily film on optical surfaces can cause false rejects or missed defects.

Cleaning Glass Surfaces

Glass surfaces that may require cleaning are:

- Camera Lens
- Beam Splitter (if present)
- Secondary lens (if present)
- Secondary mirror (if present)

To clean glass surfaces:

- Blow off dust with canned, compressed air
- Use a clean non-abrasive cloth dampened with lens cleaning solution
- Use lens tissue and lens cleaning solution on camera lenses
- If surface has compound on it, first clean with alcohol, then with lens cleaning solution

Note: Cleaning frequency will depend on plant and process conditions.

Cleaning the Chromapulse Beam Splitter

If your module has a beam splitter, clean the glass carefully.

⚠ CAUTION: Do not move the position of the glass, or else the part image will not be correct for inspection.

To clean beam splitter:

1. Blow off dust from beam splitter with canned, compressed air.
2. Clean the glass on the beam splitter using lens tissue and lens cleaner.

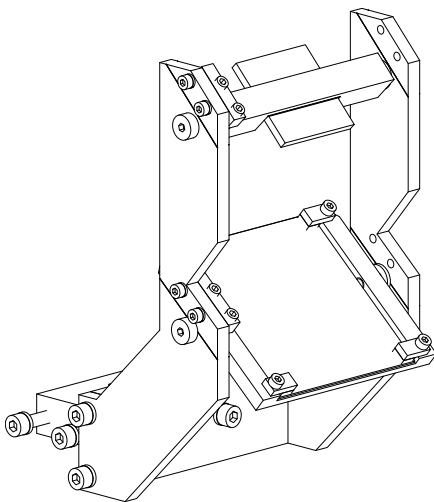

Cleaning Plastic Surfaces - general

Note: Cleaning frequency will depend on plant and process conditions.

To clean plastic surfaces:

- Use canned compressed air to blow away dust
- Use a clean, non-abrasive cloth dampened with mild soap and water solution. Saturate surface completely to let particles wash away.
- Dry the surface with clean, compressed air



DO NOT: Use paper towels, paper napkins, or dry cloths – these may scratch surfaces

Cleaning the Part Detector Without Reflector

Your system will be equipped with either a part detector or proximity sensor, depending on your application. The proximity sensor does not use a reflector. However, the cleaning procedure for either of these types of sensors is similar.

The part detect sensor and reflector surfaces of the part detector must remain clean to properly detect parts. Clean these surfaces regularly to prevent dirt and oil build-up.

To clean the part detector:

- Clean the part detector surfaces with a soft, clean, lint-free cloth dampened with a mild soap and water solution
- Clean the sensors on both sides of the conveyor
- Do not use a glass cleaning solution or strong solvent on plastic surfaces as they might be damaged.

Note: the frequency of cleaning will depend on plant and process conditions

